



**Forze teoriche,ammortizzamento, consumo d'aria**

MODELLI	Ø pollici	Lunghezza d'ammortizzamento (mm)	Volume iniziale d'ammortizzamento (cm³)	Forze teoriche (N) a 6 bar		Consumo d'aria (l/cm) per corsa a 6 bar	
				stelo esteso	Stelo retrato	stelo esteso	Stelo retrato
M/1020	2	25,5	34,3	1225	1055	0,143	0,107
M/1025	2 1/2	25,5	85,2	1930	1626	0,225	0,189
M/1030	3	25,5	126,2	2721	2417	0,317	0,282
M/1040	4	38	339	4902	4420	0,572	0,515
M/1050	5	38	528	7600	7118	0,886	0,830
M/1060	6	38	737	10887	9954	1,270	1,161
M/1080	8	51	895	19419	18486	2,265	2,157
M/1101	10	63,5	1554	30402	27680	3,547	3,229
M/1121	12	63,5	2368	43837	41115	5,114	4,797

**OPZIONI**

**★M/1★/★/★/★/★/★**

Varianti		Sostituire	Corsa (mm)	
Versioni alte temperature: 150°C		T	2500 max.	









Diametri cilindro, Stelo Ø (pollici)		Sostituire	Varianti		Sostituire
2	1	020	Standard	Nessuno	
2 1/2	1	025	Soffietto stelo*	K	
2 1/2	1 1/4	026	Doppio stelo	J	
3	1	030	stelo filettato femmina	X	
3	1 1/4	031	stelo filettato completo	Y	
4	1 1/4	040			
4	1 1/2	041			
5	1 1/4	050			
5	1 3/4	051			
6	1 3/4	060			
6	2 1/4	061			
8	1 3/4	080			
8	2 1/4	081			
10	3	101			
12	3	121			





\* Si prega di contattare il nostro servizio tecnico. Non considerare le posizioni corrispondenti alle opzioni inutilizzate, es. M/1020/100. Per eventuali combinazioni di varianti cilindro contattare il nostro Servizio Tecnico. Le guarnizioni termoresistenti non sono disponibili per tutte le varianti. Queste opzioni si riferiscono solo alle varianti cilindro. Non è possibile ricavare varianti/opzioni aggiuntive.

# M/1000 Impieghi pesanti

Doppio effetto, Ø 2" ... 12"

## FISSAGGI

Cilindri Ø pollici	Stelo Ø	B	B + G	C	D	F	G	H	K
									
2	1	QM/871	QM/1182	QM/751	M/P9822	QM/407	QM/875	M/P8635	QM/963
2 1/2	1	QM/877	QM/1184	QM/748	M/P9825	QM/407	QM/876	M/P8636	QM/965
2 1/2	1 1/4	QM/984	QM/1185	QM/747	M/P9828	QM/408	QM/878	M/P8636	QM/967
3	1	QM/987	QM/1187	QM/746	QM/758/2	QM/407	QM/887	M/P8637	QM/758/1
3	1 1/4	QM/988	QM/1188	QM/981	QM/759/2	QM/408	QM/886	M/P8637	QM/759/1
4	1 1/4	QM/884/1	QM/1189	QM/826	QM/761/2	QM/408	QM/884/2	M/P8638	QM/761/1
4	1 1/2	QM/889/1	-	QM/745	QM/762/2	QM/409	QM/883/2	M/P8638	QM/762/1
5	1 1/4	QM/882/2	-	QM/744	-	QM/408	QM/882/2	M/P8639	-
5	1 3/4	QM/889/1	-	QM/743	-	QM/410	QM/889/2	M/P8639	-
6	1 3/4	-	-	-	-	QM/410	-	M/P8640	-
6	2 1/4	-	-	-	-	QM/411	-	M/P8640	-
8	1 3/4	-	-	-	-	QM/410	-	M/P8645	-
8	2 1/4	-	-	-	-	QM/411	-	M/P8645	-
10	3	-	-	-	-	QM/412	-	M/P8667	-
12	3	-	-	-	-	QM/412	-	M/P8670	-

Cilindri Ø pollici	Stelo Ø	L	M	N	R
					
2	1	QM/909	QM/901	M/P9693/1	M/P10349
2 1/2	1	QM/910	QM/901	M/P9693/2	M/P10351
2 1/2	1 1/4	QM/910	QM/902	M/P9693/2	M/P10353
3	1	QM/911	QM/901	M/P9693/4	QM/763
3	1 1/4	QM/911	QM/902	-	QM/764
4	1 1/4	QM/912	QM/902	-	QM/765
4	1 1/2	QM/912	QM/903	-	QM/766
5	1 1/4	QM/913	QM/902	-	QM/767
5	1 3/4	QM/913	QM/904	-	QM/768
6	1 3/4	QM/914	QM/904	-	-
6	2 1/4	QM/914	QM/906	-	-
8	1 3/4	QM/915	QM/904	-	-
8	2 1/4	QM/915	QM/906	-	-
10	3	QM/917	QM/921	-	-
12	3	QM/918	QM/921	-	-

## DIMENSIONI BASE

### M/1000 – Cilindri standard

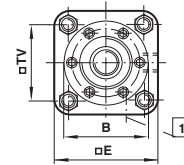
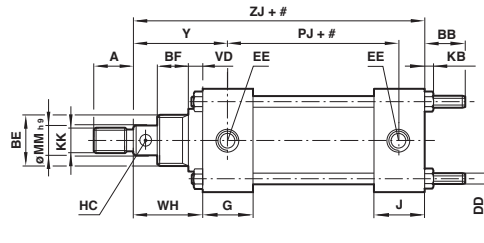

# Corsa  
1 Viti di ammortamento

MODELLI	Ø pollici	A	B	BB	BE	BF	DD	E	EE	G	Ø HC	J
M/1020	2	33,5	51	28	M 45 x 2	30	M 8	63,5	G 1/4	37	8	37
M/1025	2 1/2	33,5	58	31	M 52 x 2	35	M 8	76	G 3/8	37	8	37
M/1026	2 1/2	38	58	31	M 52 x 2	35	M 8	76	G 3/8	37	8	37
M/1030	3	33,5	64	37	M 52 x 2	38	M 10	90	G 1/2	38	8	38
M/1031	3	38	64	37	M 52 x 2	38	M 10	90	G 1/2	38	8	38
M/1040	4	38	89	29	M 64 x 2	46	M 10	114	G 1/2	46	8	46
M/1041	4	47,5	89	29	M 64 x 2	46	M 10	114	G 1/2	46	8	46
M/1050	5	38	108	39	-	41	M 12	140	G 1/2	48	8	48
M/1051	5	57	108	39	-	41	M 12	140	G 1/2	48	8	48
M/1060	6	57	127	48	-	52,5	M 16	167	G 3/4	43	10	43
M/1061	6	76	127	48	-	52,5	M 16	167	G 3/4	43	10	43
M/1080	8	57	168	57	-	65	M 18	219	G 1	60	10	60
M/1081	8	76	168	57	-	65	M 18	219	G 1	60	10	60
M/1101	10	95,5	210	68	-	76,5	M 24	270	G 1	70	16	70
M/1121	12	95,5	210	68	-	76,5	M 24	321	G 1	70	16	70

  

MODELLI	Ø pollici	KB	KK	Ø MM $\varnothing$	PJ	TV	VD	WH	Y	ZJ	a 0 mm	per 25 mm
M/1020	2	7,5	M 22	1 pollici	90,5	47,5	9,5	55,5	71	178	3,27 kg	0,27 kg
M/1025	2 1/2	7,5	M 22	1 pollici	92,5	55,5	12,5	63	80,5	190,5	4,49 kg	0,35 kg
M/1026	2 1/2	7,5	M 24	1 1/4 pollici	92,5	55,5	12,5	63	80,5	190,5	4,57 kg	0,41 kg
M/1030	3	9	M 22	1 pollici	98,5	66,5	14,5	68	85,5	201,5	5,63 kg	0,45 kg
M/1031	3	9	M 24	1 1/4 pollici	98,5	66,5	14,5	68	85,5	201,5	5,73 kg	0,50 kg
M/1040	4	9	M 24	1 1/4 pollici	98,5	89	11	76	103	228,5	10,92 kg	0,62 kg
M/1041	4	9	M 30	1 1/2 pollici	98,5	89	11	76	103	228,5	11,33 kg	0,69 kg
M/1050	5	11	M 24	1 1/4 pollici	114,5	108	13	73	100	241,5	15,26 kg	0,79 kg
M/1051	5	11	M 36	1 3/4 pollici	114,5	108	13	76	103	244,5	15,82 kg	0,94 kg
M/1060	6	14	M 36	1 3/4 pollici	114,5	128,5	16	100	123,5	262	27,23 kg	1,17 kg
M/1061	6	14	M 48	2 1/4 pollici	114,5	128,5	16	100	123,5	262	28,00 kg	1,37 kg
M/1080	8	16,5	M 36	1 3/4 pollici	140	168,5	19	115,5	150,5	325,5	61,18 kg	1,57 kg
M/1081	8	16,5	M 48	2 1/4 pollici	140	168,5	19	115,5	150,5	325,5	62,00 kg	1,77 kg
M/1101	10	20,5	M 64 x 4	3 pollici	197	209,5	22	130	174,5	416	122,00 kg	2,75 kg
M/1121	12	20,5	M 64 x 4	3 pollici	197	246	22	130	174,5	416	160,00 kg	3,74 kg

## ALTRE VERSIONI

### M/1000/X – Estremità stelo X

MODELLI	Ø pollici	AF	Ø HC	KF	WG
M/1020	2	29	8	M 18	84
M/1025	2 1/2	29	8	M 18	91,5
M/1026	2 1/2	38	8	M 24	104,5
M/1030	3	29	8	M 18	99,5
M/1031	3	38	8	M 24	109,5
M/1040	4	38	8	M 24	117
M/1041	4	48	8	M 30	127
M/1050	5	38	8	M 24	114
M/1051	5	57	8	M 30	133
M/1060	6	57	10	M 30	157
M/1061	6	76	10	M 42	176
M/1080	8	57	10	M 30	173
M/1081	8	76	10	M 42	195
M/1101	10	95	16	M 64 x 4	228,5
M/1121	12	95	16	M 64 x 4	228,5

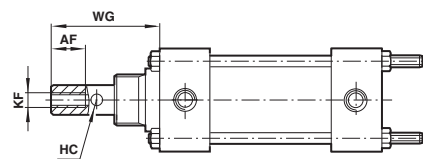

### M/1000/Y – Estremità stelo Y

MODELLI	Ø pollici	AA	Ø HC	KM	WD
M/1020	2	58	8	M 24	58
M/1025	2 1/2	58	8	M 24	65,5
M/1026	2 1/2	73	8	M 30	66,5
M/1030	3	58	8	M 24	70,5
M/1031	3	73	8	M 30	71
M/1040	4	73	8	M 30	79
M/1041	4	88	8	M 36	80
M/1050	5	73	8	M 30	76
M/1051	5	103	8	M 42	77,5
M/1060	6	103	10	M 42	101,5
M/1061	6	134	10	M 56 x 4	102
M/1080	8	103	10	M 42	117
M/1081	8	134	10	M 56 x 4	118
M/1101	10	180	16	M 76 x 4	134
M/1121	12	180	16	M 76 x 4	134

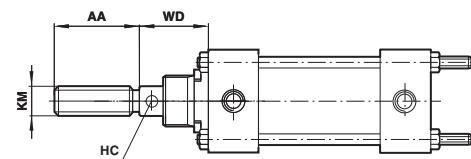

# M/1000 Impieghi pesanti

Doppio effetto, Ø 2" ... 12"

## FISSAGGI

Flangia anteriore - B o G

Flangia anteriore - BG

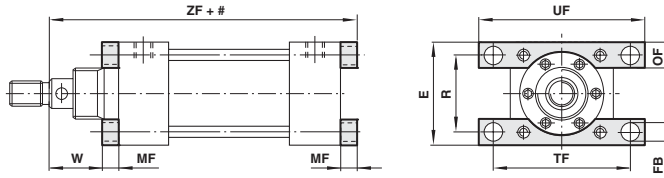

# Corsa

MODELLI B	MODELLI BG	MODELLI G	Per cilindri	Ø pollici	E	Ø FB	MF	OF	R	TF	UF	W	ZF	Leggera
QM/871	QM/1182	QM/875	1020	2	63,5	8,7	10	16	47,5	85,5	105	45,5	187,5	0,20 kg
QM/877	QM/1184	QM/876	1025	2 1/2	75,5	8,7	10	20	55,5	93,5	113	53	200,5	0,25 kg
QM/877	QM/1184	QM/876	1026	2 1/2	75,5	8,7	10	20	55,5	93,5	113	53	200,5	0,25 kg
QM/984	QM/1185	QM/878	1030	3	88,5	10,3	16	22	66,5	111	133,5	52	217,5	0,45 kg
QM/984	QM/1185	QM/878	1031	3	88,5	10,3	16	22	66,5	111	133,5	52	217,5	0,45 kg
QM/987	QM/1187	QM/887	1040	4	121	13,5	16	32	89	146	178	60	244	1,00 kg
QM/987	QM/1187	QM/887	1041	4	121	13,5	16	32	89	146	178	60	244	1,00 kg
QM/988	QM/1188	QM/886	1050	5	148	13,5	20	40	108	171,5	203	53 (56,5)*	261(264,5)*	1,50 kg
QM/988	QM/1188	QM/886	1051	5	148	13,5	20	40	108	171,5	203	53 (56,5)*	261(264,5)*	1,50 kg
QM/884/1	QM/1189	QM/884/2	1060	6	168,5	16,7	20	40	128,5	205	243	80	282,5	2,40 kg
QM/884/1	QM/1189	QM/884/2	1061	6	168,5	16,7	20	40	128,5	205	243	80	282,5	2,40 kg
QM/889/1	-	QM/883/2	1080	8	218,5	20	25	50	168,5	263,5	314,5	90,5	350	5,50 kg
QM/889/1	-	QM/883/2	1081	8	218,5	20	25	50	168,5	263,5	314,5	90,5	350	5,50 kg
QM/882/2	-	QM/882/2	1101	10	274,5	26,2	30	65	209,5	333,5	397	100	446,5	12,00 kg
QM/889/1	-	QM/889/2	1121	12	311	26,2	30	65	246	384	448	100	446,5	14,00 kg

\* I valori per M/1051

## Piedini - C

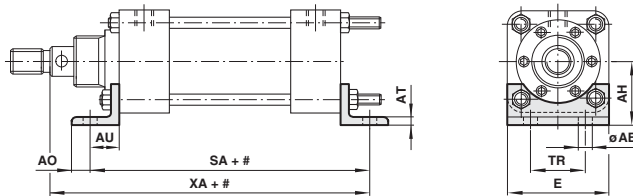

# Corsa

MODELLI	Ø pollici	Per cilindri	Ø AB	AH	AO	AT	AU	E	SA	TR	XA	Leggera
QM/751	2	1020	13	43	11	5	19	63,5	160	-	196,5	0,20 kg
QM/748	2 1/2	1025	13	47	11	5	19	75,5	165	-	209,5	0,25 kg
QM/748	2 1/2	1026	13	47	11	5	19	75,5	165	-	209,5	0,25 kg
QM/747	3	1030	12	52,5	11	5	19	88,5	171	28,5	220,5	0,40 kg
QM/747	3	1031	12	52,5	11	5	19	88,5	171	28,5	220,5	0,40 kg
QM/746	4	1040	13,5	70	24,5	8	25,5	121	203	51	253,5	0,50 kg
QM/746	4	1041	13,5	70	24,5	8	25,5	121	203	51	253,5	0,50 kg
QM/981	5	1050	16,5	82,5	21,5	8	28,5	148	225	57	269,5 (273)*	1,00 kg
QM/981	5	1051	16,5	82,5	21,5	8	28,5	148	225	57	269,5 (273)*	1,00 kg
QM/826	6	1060	16,5	99,5	25	10	35	168,5	232	70	297,5	2,50 kg
QM/826	6	1061	16,5	99,5	25	10	35	168,5	232	70	297,5	2,50 kg
QM/745	8	1080	16,5	122	22	10	38	218,5	285	82,5	363	3,80 kg
QM/745	8	1081	16,5	122	22	10	38	218,5	285	82,5	363	3,80 kg
QM/744	10	1101	26	159	46	15	54	274,5	394	114,5	470,5	9,50 kg
QM/743	12	1121	26	177	46	15	54	311	394	139	470,5	11,50 kg

\* I valori per M/1051

## Dado nasello - N

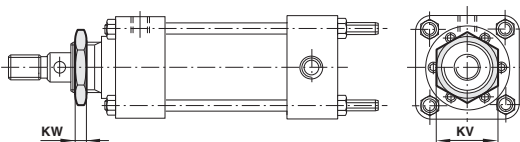

MODELLI N	Per cilindri	Ø pollici	KV	KW	Leggera
M/P9693/1	1020	2	56	8	0,06 kg
M/P9693/2	1025	2 1/2	65,5	9,5	0,06 kg
M/P9693/2	1026	2 1/2	65,5	9,5	0,06 kg
M/P9693/2	1030	3	65,5	9,5	0,06 kg
M/P9693/2	1031	3	65,5	9,5	0,06 kg
M/P9693/4	1040	4	80	16	0,18 kg
M/P9693/4	1041	4	80	16	0,18 kg

### Forcella stelo - F

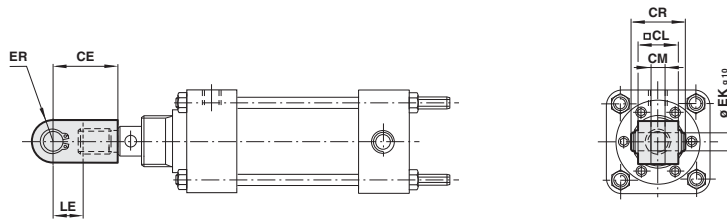

MODELLI	Per cilindri	Ø pollici	CE	□CL	CM	CR	Ø EK <sub>g10</sub>	ER	LE	Leggera
QM/407	1020	2	58,5	38	14	47	16	19	25,5	0,40 kg
QM/407	1025	2 1/2	58,5	38	14	47	16	19	25,5	0,40 kg
QM/408	1026	2 1/2	66,5	44,5	16	53	18	22	28,5	0,40 kg
QM/407	1030	3	58,5	38	14	47	16	19	25,5	0,40 kg
QM/408	1031	3	66,5	44,5	16	53	18	22	28,5	0,40 kg
QM/408	1040	4	66,5	44,5	16	53	18	22	28,5	0,90 kg
QM/409	1041	4	79,5	51	20	60	22	25	32	0,90 kg
QM/408	1050	5	66,5	44,5	16	53	18	22	28,5	0,90 kg
QM/410	1051	5	95,5	63,5	25	74	25	32	38	0,90 kg
QM/410	1060	6	95,5	63,5	25	74	25	32	38	1,70 kg
QM/411	1061	6	120,5	76	32	87	32	38	44,5	1,70 kg
QM/410	1080	8	95,5	63,5	25	74	25	32	38	1,70 kg
QM/411	1081	8	120,5	76	32	87	32	38	44,5	1,70 kg
QM/412	1101	10	146	89	38	99	38	45	51	7,00 kg
QM/412	1121	12	146	89	38	99	38	45	51	7,00 kg

### Cerniera posteriore - D

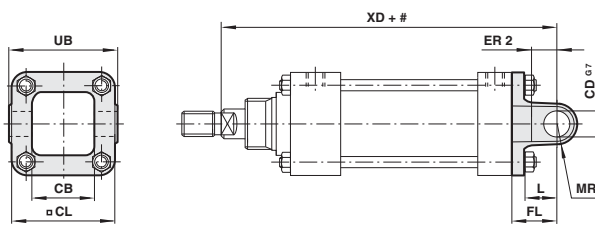

# Corsa

MODELLI	Per cilindri	Ø pollici	CB	Ø CD <sup>67</sup>	□CL	ER 1	FL	L	MR	UB	XD	Leggera
M/P9822	1020	2	47,5	16	63,5	19	28,5	20,5	14	69,9	206	0,25 kg
M/P9825	1025	2 1/2	54	16	76	19	28,5	20,5	13	82,6	219	0,50 kg
M/P9825	1026	2 1/2	54	16	76	19	28,5	20,5	13	82,6	219	0,50 kg
M/P9828	1030	3	57	20	89	22	32	24	14	95,3	233,5	1,00 kg
M/P9828	1031	3	57	20	89	22	32	24	14	95,3	233,5	1,00 kg
QM/758/2	1040	4	70	22	114,5	36	57	38	19	122,5	285,5	1,25 kg
QM/758/2	1041	4	70	22	114,5	36	57	38	19	122,5	285,5	1,25 kg
QM/759/2	1050	5	92	25	139,5	31	70	44,5	24	152,5	311*	2,50 kg
QM/759/2	1051	5	92	25	139,5	31	70	44,5	24	152,5	311*	2,50 kg
QM/761/2	1060	6	106,5	32	166,5	34	76	49	29	181	338,5	3,50 kg
QM/761/2	1061	6	106,5	32	166,5	34	76	49	29	181	338,5	3,50 kg
QM/762/2	1080	8	122	38	217,5	38	85,5	57	38	237	411	7,00 kg
QM/762/2	1081	8	122	38	217,5	38	85,5	57	38	237	411	7,00 kg

### Fissaggio cerniera anteriore - K

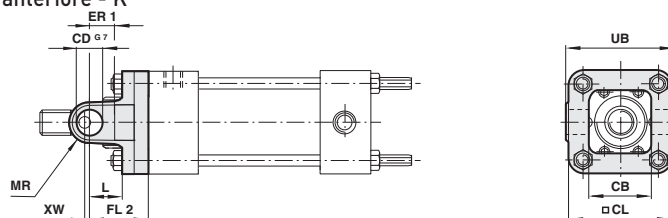

# Corsa

MODELLI	Per cilindri	Ø pollici	CB	Ø CD <sup>67</sup>	□CL	ER 1	FL 2	L	MR	UB	XW	Leggera
QM/963	1020	2	47,5	16	63,5	19	38,5	20,5	14	69,9	17	0,25 kg
QM/965	1025	2 1/2	54	16	76	19	44,5	20,5	13	82,6	19	0,50 kg
QM/965	1026	2 1/2	54	16	76	19	44,5	20,5	13	82,6	19	0,50 kg
QM/967	1030	3	57	20	89	22	47	24	14	95,3	21,5	1,00 kg
QM/967	1031	3	57	20	89	22	47	24	14	95,3	21,5	1,00 kg
QM/758/1	1040	4	70	22	114,5	36	57	38	19	122,5	19	1,25 kg
QM/758/1	1041	4	70	22	114,5	36	57	38	19	122,5	19	1,25 kg
QM/759/1	1050	5	92	25	139,5	31	70	44,5	24	152,5	3	2,50 kg
QM/759/1	1051	5	92	25	139,5	31	70	44,5	24	152,5	3	2,50 kg
QM/761/1	1060	6	106,5	32	166,5	34	76	49	29	181	24	3,50 kg
QM/761/1	1061	6	106,5	32	166,5	34	76	49	29	181	24	3,50 kg
QM/762/1	1080	8	122	38	217,5	38	85,5	57	38	237	30,5	7,00 kg
QM/762/1	1081	8	122	38	217,5	38	85,5	57	38	237	30,5	7,00 kg

# M/1000 Impieghi pesanti

Doppio effetto, Ø 2" ... 12"

## Forcella e controforcella - L

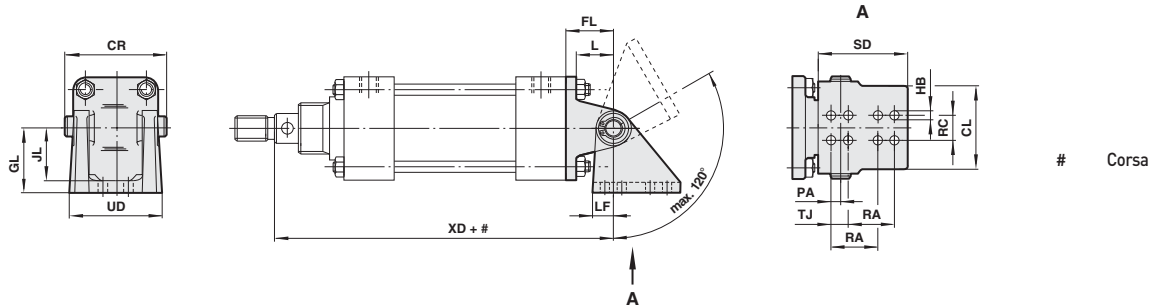

MODELLI	Per cilindri	Ø pollici	CL	CR	FL	GL	Ø HB	JL	L	LF	PA	RA	RC	SD	TJ	UD	XD	Leggera
QM/909	1020	2	60	73	35	47,5	8,3	39,5	25,5	15,5	6,5	47,5	19	66,5	-	68,5	212,5	1,20 kg
QM/910	1025	2 1/2	60	73	35	47,5	8,3	39,5	25,5	15,5	6,5	47,5	19	66,5	-	68,5	225,5	1,25 kg
QM/910	1026	2 1/2	60	73	35	47,5	8,3	39,5	25,5	15,5	6,5	47,5	19	66,5	-	68,5	225,5	1,25 kg
QM/911	1030	3	60	73	35	47,5	8,3	39,5	25,5	15,5	6,5	47,5	19	66,5	-	68,5	236,5	1,50 kg
QM/911	1031	3	60	73	35	47,5	8,3	39,5	25,5	15,5	6,5	47,5	19	66,5	-	68,5	236,5	1,50 kg
QM/912	1040	4	70	82,5	51	74,5	12	39,5	30	23,5	11	76	22	101,5	-	82,5	279	3,50 kg
QM/912	1041	4	70	82,5	51	74,5	12	39,5	30	23,5	11	76	22	101,5	-	82,5	279	3,50 kg
QM/913	1050	5	70	82,5	57	74,5	12	65	33,5	23,5	11	76	22	101,5	-	82,5	298	5,00 kg
QM/913	1051	5	70	82,5	57	74,5	12	65	33,5	23,5	11	76	22	101,5	-	82,5	301,5	5,00 kg
QM/914	1060	6	98,5	114,5	70	89	13,5	76	43	28	12,5	101,5	32	165	32	108	332	11,00 kg
QM/914	1061	6	98,5	114,5	70	89	13,5	76	43	28	12,5	101,5	32	165	32	108	332	11,00 kg
QM/915	1080	8	100	114,5	79,5	116	16,5	100	47,5	31,5	16	114,5	32	184	38	117,5	404,5	17,50 kg
QM/915	1081	8	100	114,5	79,5	116	16,5	100	47,5	31,5	16	114,5	32	184	38	117,5	404,5	17,50 kg
QM/917	1101	10	151	178	95,5	171,5	27	151	57	44,5	16	133,5	51	247,5	57	159	511,5	25,00 kg
QM/918	1121	12	151	178	95,5	171,5	27	151	57	44,5	16	133,5	51	247,5	57	159	511,5	30,00 kg

## Forcella e controforcella - M

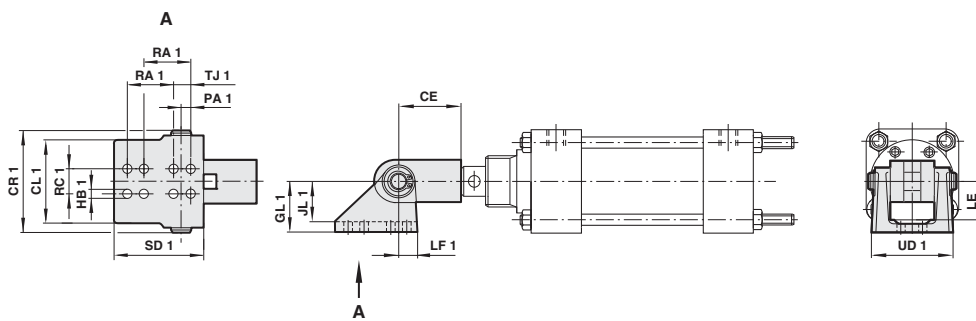

MODELLI	Per cilindri	Ø pollici	CE	CL 1	CR 1	GL 1	Ø HB 1	JL 1	LE	LF 1	PA 1	RA 1	RC 1	SD 1	TJ 1	UD 1	Leggera
QM/901	1020	2	58,5	60	73	47,5	8,5	39,5	35	16	6,5	47,5	19	67	-	68,5	1,00 kg
QM/901	1025	2 1/2	58,5	60	73	47,5	8,5	39,5	35	16	6,5	47,5	19	67	-	68,5	1,00 kg
QM/902	1026	2 1/2	66,5	70	82,5	74,5	12	65	57	24	11	76	22	102	-	82,5	1,00 kg
QM/901	1030	3	58,5	60	73	47,5	8,5	39,5	35	16	6,5	47,5	19	67	-	68,5	1,00 kg
QM/902	1031	3	66,5	70	82,5	74,5	12	65	57	24	11	76	22	102	-	82,5	1,00 kg
QM/902	1040	4	66,5	70	82,5	74,5	12	65	57	24	11	76	22	102	-	82,5	2,00 kg
QM/903	1041	4	79,5	79,5	92	89	10,3	79,5	79,5	28,5	16	89	22	114,5	-	79,5	2,00 kg
QM/904	1050	5	66,5	70	82,5	74,5	12	65	57	24	11	76	22	102	-	82,5	2,00 kg
QM/904	1051	5	95,5	98,5	114,5	89	13,5	76	55,5	28,5	12,5	102	32	165	32	108	2,00 kg
QM/904	1060	6	95,5	98,5	114,5	89	13,5	76	55,5	28,5	12,5	102	32	165	32	108	2,00 kg
QM/906	1061	6	120,5	114,5	132	116	13,5	103	103	35	16	121	38	159	-	114,5	6,00 kg
QM/904	1080	8	95,5	98,5	114,5	89	13,5	76	55,5	28,5	12,5	102	32	165	32	108	6,00 kg
QM/906	1081	8	120,5	114,5	132	116	13,5	103	103	35	16	121	38	159	-	114,5	6,00 kg
QM/921	1101	10	146	146	165	116	23	100	100	45	19	114,5	41	210	44,5	146	11,50 kg
QM/921	1121	12	146	146	165	116	23	100	100	45	19	114,5	41	210	44,5	146	11,50 kg

## Snodo mediano - H

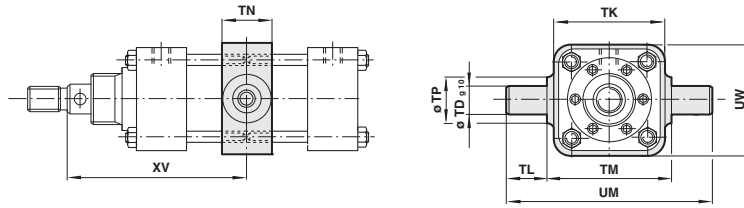

# Corsa

MODELLI	Per cilindri	Ø pollici	Ø TD <sub>g10</sub>	TK	TL	TM	TN	Ø TP	UM	UW	XV min	XV max	Leggera
M/P8635	1020	2	18	70	25,5	79,5	32	29	130	70	108,5	123	0,60 kg
M/P8636	1025	2 1/2	22	81	32	90,5	38	35	154	81	119	134,5	0,90 kg
M/P8636	1026	2 1/2	22	81	32	90,5	38	35	154	81	119	134,5	0,90 kg
M/P8637	1030	3	25	95	38	108	38	38	184	95	125	144,5	1,25 kg
M/P8637	1031	3	25	95	38	108	38	38	184	95	125	144,5	1,25 kg
M/P8638	1040	4	32	127	41,5	139,5	44,5	45	222,5	127	144,5	160	2,50 kg
M/P8638	1041	4	32	127	41,5	139,5	44,5	45	222,5	127	144,5	160	2,50 kg
M/P8639	1050	5	38	152,5	51	165	51	51	266,5	152,5	146,5	168	3,50 kg
M/P8639	1051	5	38	152,5	51	165	51	51	266,5	152,5	149,5	171	3,50 kg
M/P8640	1060	6	38	187,5	51	192	51	51	293,5	187,5	168,5	193,5	5,00 kg
M/P8640	1061	6	38	187,5	51	192	51	51	293,5	187,5	168,5	193,5	5,00 kg
M/P8645	1080	8	45	241,5	54	247,5	70	64	355,5	245	210,5	230,5	10,00 kg
M/P8645	1081	8	45	241,5	54	247,5	70	64	355,5	245	210,5	230,5	10,00 kg
M/P8667	1101	10	65	330	76	330	76	114,5	482,5	318	238	308	25,00 kg
M/P8670	1121	12	75	381	76	381	89	127	533,5	369	244,5	301,5	35,00 kg

Nota: Questi fissaggi vengono forniti unicamente assemblati con cilindro. Se non diversamente specificato, le unità verranno fornite con dimensioni "XV", più metà della lunghezza corsa.

## Cerniera maschio - R

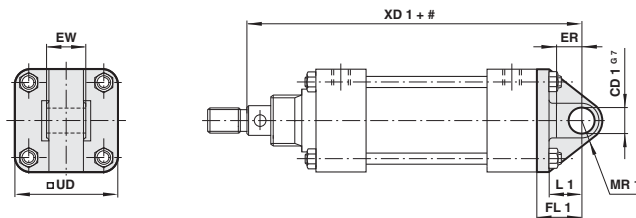

# Corsa

MODELLI	Per cilindri	Ø pollici	Ø CD 1 <sub>e7</sub>	ER	EW	FL 1	L 1	MR 1	UD	XD 1	Leggera
M/P10349	1020	2	16	19	38,1	35	25,5	14	62	212,5	0,55 kg
M/P10351	1025	2 1/2	16	19	38,1	35	25,5	14	74	225,5	0,80 kg
M/P10351	1026	2 1/2	16	19	38,1	35	25,5	14	74	225,5	0,80 kg
M/P10353	1030	3	16	19	38,1	35	25,5	16	87,5	236,5	0,90 kg
M/P10353	1031	3	16	19	38,1	35	25,5	16	87,5	236,5	0,90 kg
QM/763	1040	4	18	25,5	44,5	51	30	21	112	279	2,60 kg
QM/763	1041	4	18	25,5	44,5	51	30	21	112	279	2,60 kg
QM/764	1050	5	18	28,5	44,5	57	33,5	21	138	298*	3,60 kg
QM/764	1051	5	18	28,5	44,5	57	33,5	21	138	298*	3,60 kg
QM/765	1060	6	25	28,5	63,5	70	43	25,5	165	332	6,20 kg
QM/765	1061	6	25	28,5	63,5	70	43	25,5	165	332	6,20 kg
QM/766	1080	8	25	32	63,5	79,5	47,5	25,5	217,5	404,5	11,50 kg
QM/766	1081	8	25	32	63,5	79,5	47,5	25,5	217,5	404,5	11,50 kg
QM/767	1101	10	38	44,5	101,6	95,5	57,5	41	268,5	511,5	12,60 kg
QM/768	1121	12	38	44,5	101,6	95,5	57,5	41	319	511,5	17,30 kg